

# Power Choke

## JSHC1054 Series

### Automotive-Grade A0

**JinLai's proven design and process support high reliability, high thermal characteristics, and high efficiency power chokes for automotive application.**

#### DATA SHEET

**Production address: Chongqing**



## 目 录

1. Features	4
2. Application	4
3. Part No. Definition	4
4. Appearance and dimensions	4
5. Electrical Characteristics	5
6. Heat rating current VS saturation current curv	6
7. Packaging Specifications	8



## 5. Electrical Characteristics

Part Number	Inductance	Tolerance	RDC(mΩ)		Isat(A)		Irms(A)	
	(uH)	(±%)	Typical	Max	Typical	Max	Typical	Max
JSHC1054H-2R2M-K-A5	2.2	20	4.7	5.2	24.0	21.6	22.0	19.8
JSHC1054H-3R3M-K-A5	3.3	20	7.2	8.0	20.0	18.0	12.6	11.3
JSHC1054H-4R7M-K-A5	4.7	20	12.0	13.5	18.0	16.2	11.2	10.1
JSHC1054H-100M-K-A5	10.0	20	23.0	28.0	11.0	9.9	8.5	7.6
JSHC1054H-150M-K-A5	15.0	20	34.0	39.5	9.0	8.1	7.2	6.5
JSHC1054H-220M-K-A5	22.0	20	46.8	52.0	6.8	6.1	5.0	4.5
JSHC1054H-330M-K-A5	33.0	20	67.5	75.0	5.8	5.2	4.4	4.0
JSHC1054H-470M-K-A5	47.0	20	96.0	107.8	4.9	4.4	4.2	3.8
JSHC1054H-680M-K-A5	68.0	20	167.4	186.0	3.5	3.2	2.3	2.1

**Note: When ordering, please specify tolerance code. Tolerance: M=±20%**

- All data is tested on 25°C ambient temperature.
- Inductance is tested at 100kHz, 1.0V.
- Heat rating current: The value of DC current when product temperature rise is  $\Delta T40^{\circ}\text{C}$  ( $T_a=25^{\circ}\text{C}$ ).
- Saturation current: The value of DC current when the inductance decreases approximately 30% of its.

Special remind: Circuit design, component placement, frequency, cooling system and etc.  
all will affect the product temperature. Please verify the actual product temperature in the final application.

6.Heat rating current VS saturation current curv

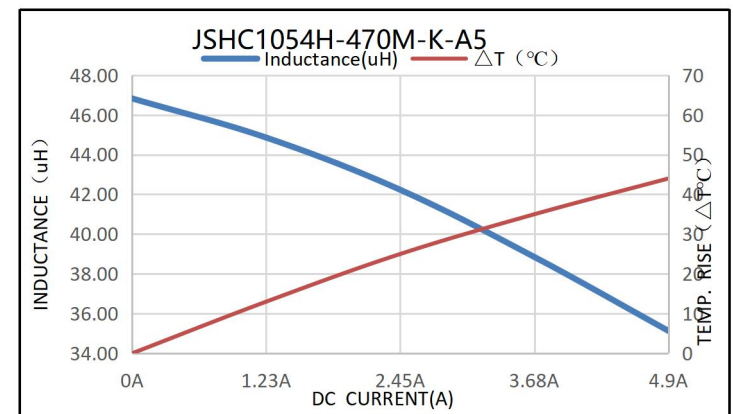
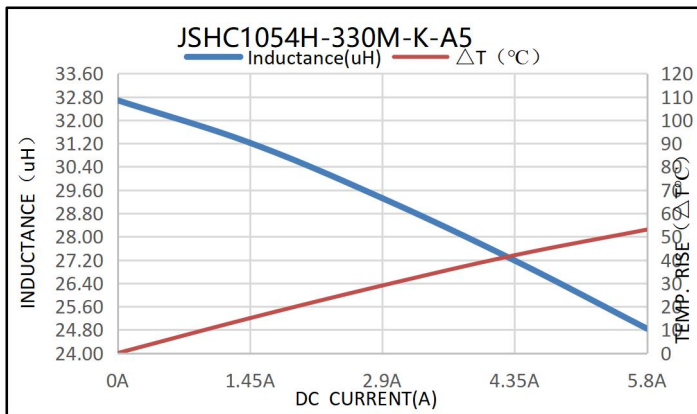
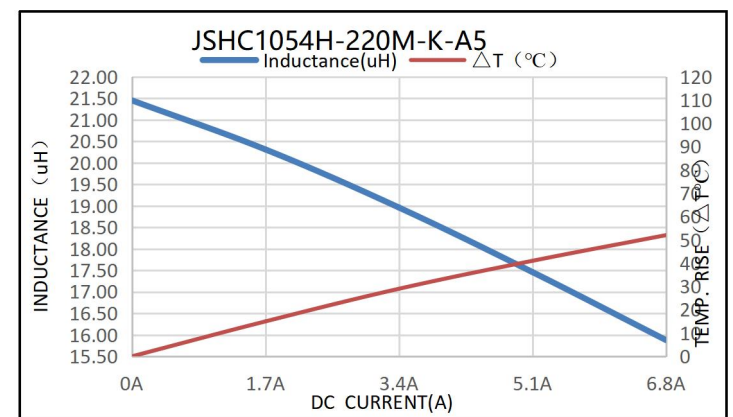
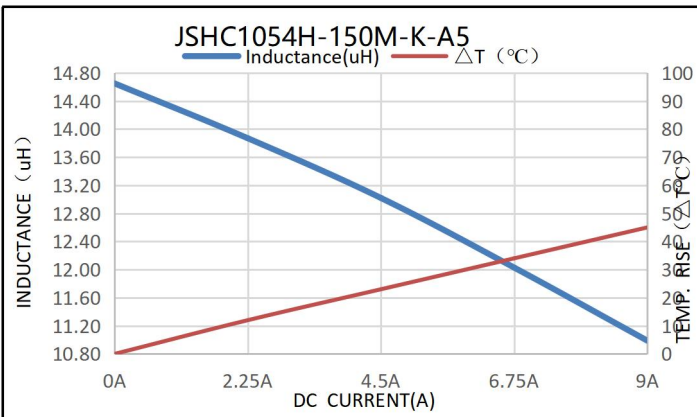
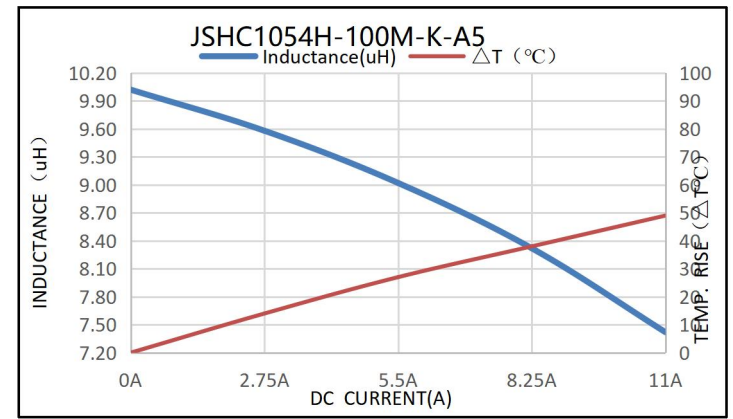
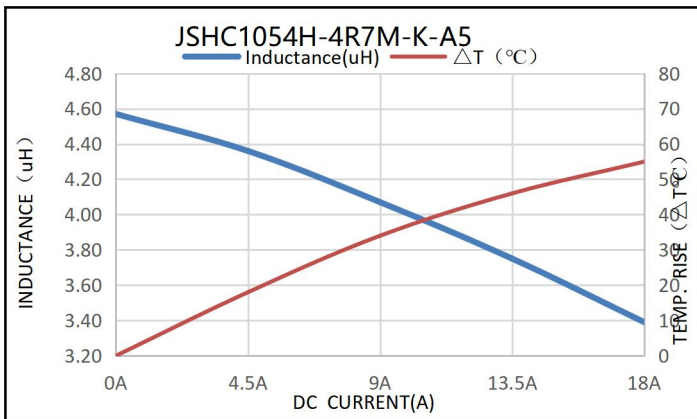
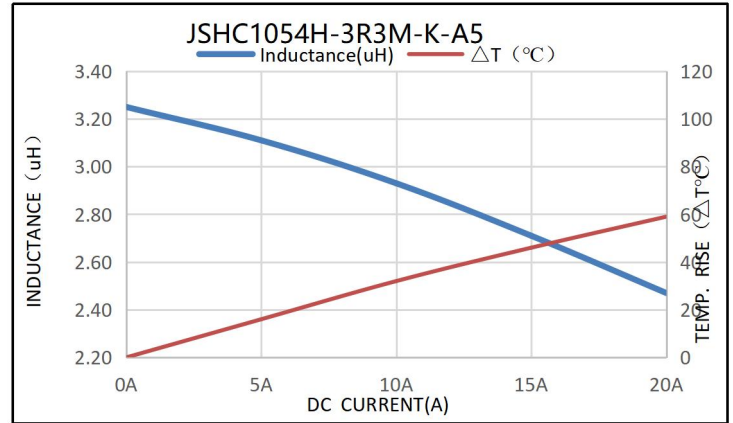
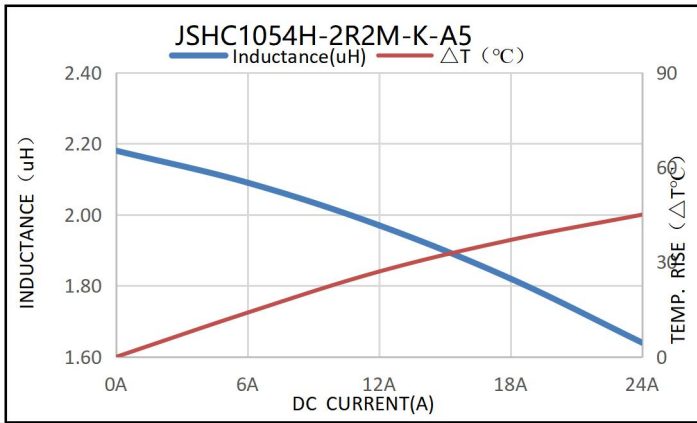

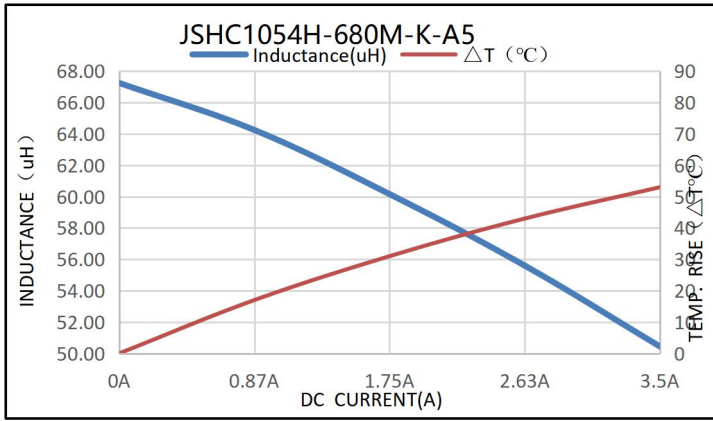

7.Packaging Specifications

Carrier tape dimensions

A0	10.6±0.2
B0	10.65±0.2
K0	5.8±0.15
W	24.0±0.3
P	16.0±0.1
F	11.5±0.1
T	0.40±0.05
D0	1.5±0.10

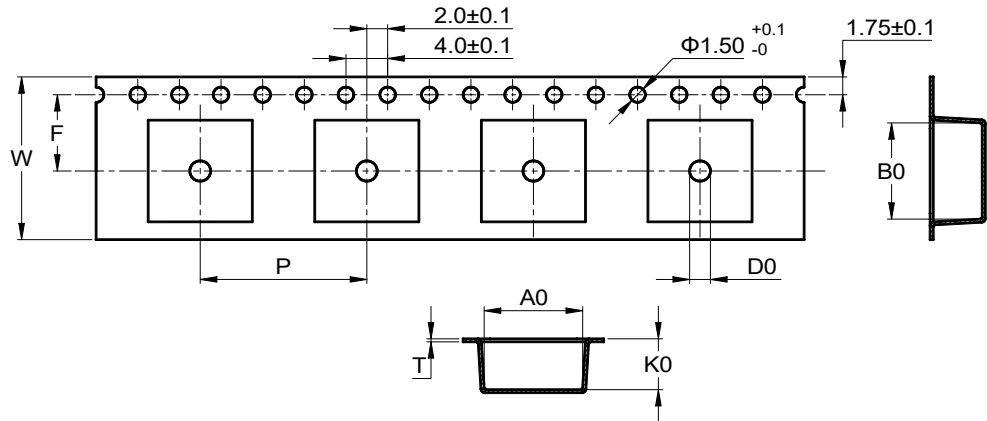

※ 包装参照国际标准 IEC 60286-3。  
Packaging is referred to the international standard IEC 60286-3.

Packaging direction

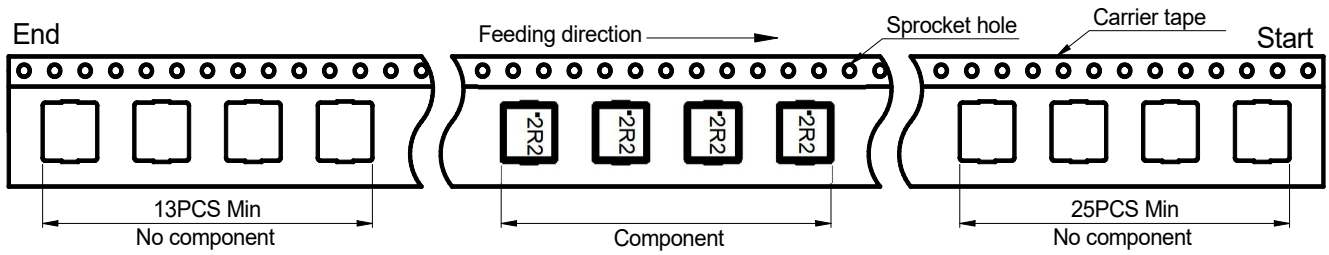

Reel dimensions

A	330 ± 2.0
B	100 Min
C	28.0 Max
D	24.5 Min

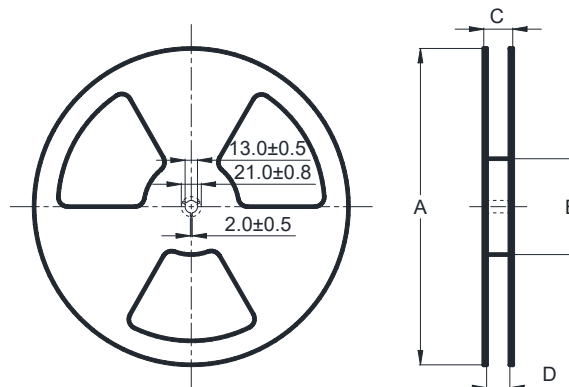



Cover tape peel-off condition

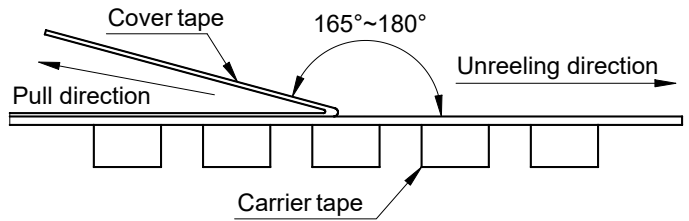
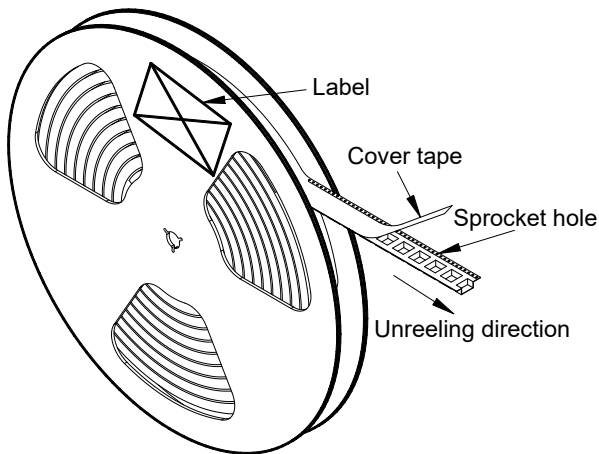

※ 盖带剥离力度为 0.1~1.3N。  
Cover tape peel-off force will be 0.1 to 1.3N.  
※ 参考剥离速度 300±10mm/分钟。  
Reference peel-off speed 300±10mm/min.

Carton dimensions and packaging quantity

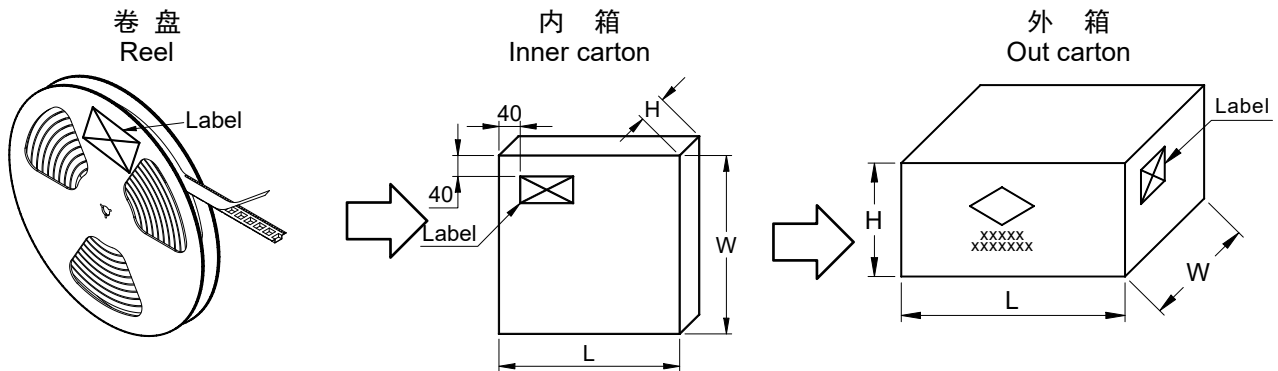

■ 内包装箱(L×W×H): 340×340×66mm  
Inner Carton

■ 外包装箱(L×W×H): 360×360×215mm  
Out Carton

SHC1054	每盘 包装数量 Per Reel Quantity	内箱 包装数量 Inner Carton Quatity	外箱 包装数量 Out Carton Quantity
	500 pcs	(500×2) = 1,000 pcs	(1,000×3) = 3,000 pcs